

タオルハンガー型紙

側板 -2 背板 -3

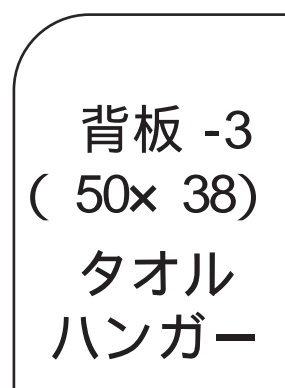

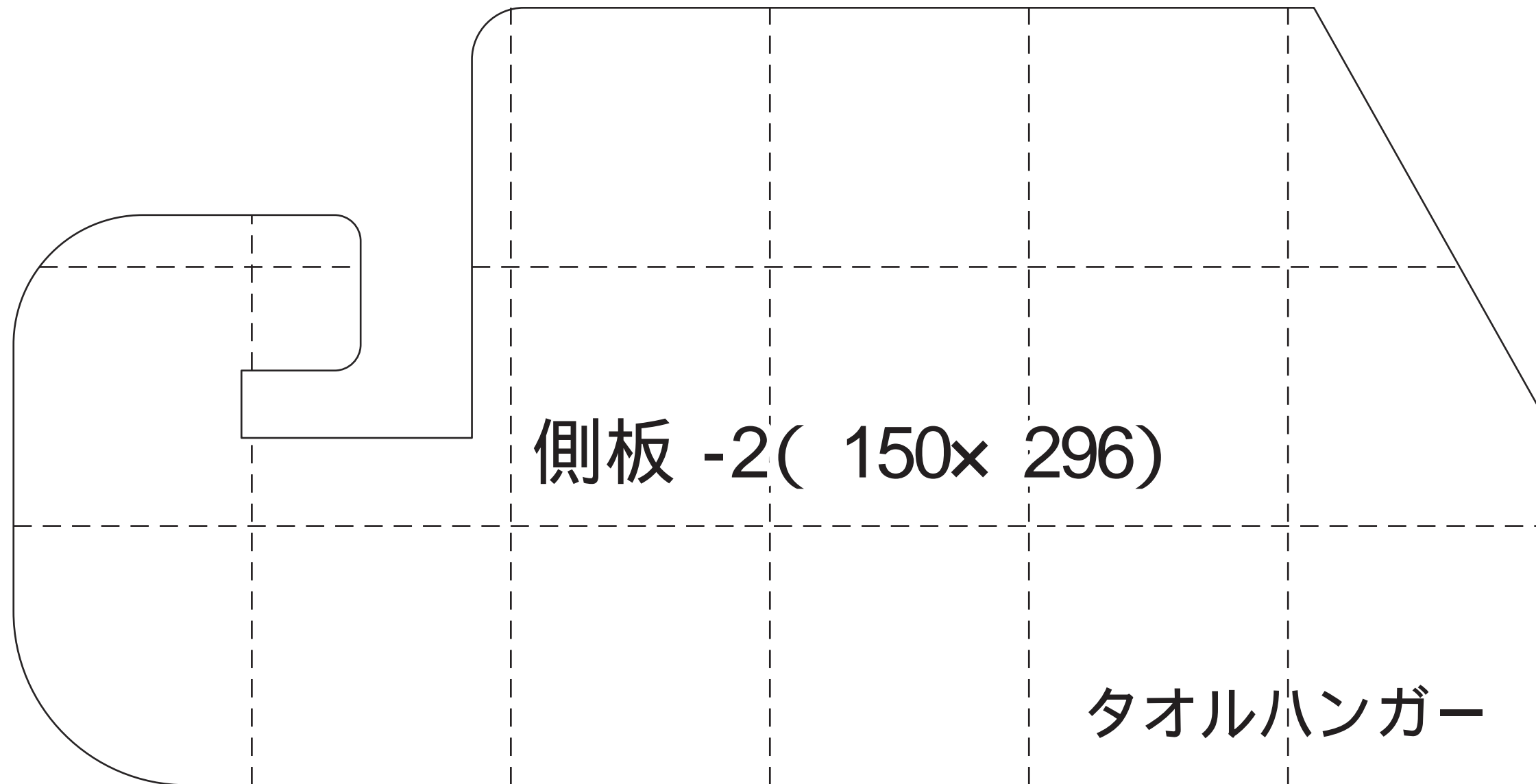
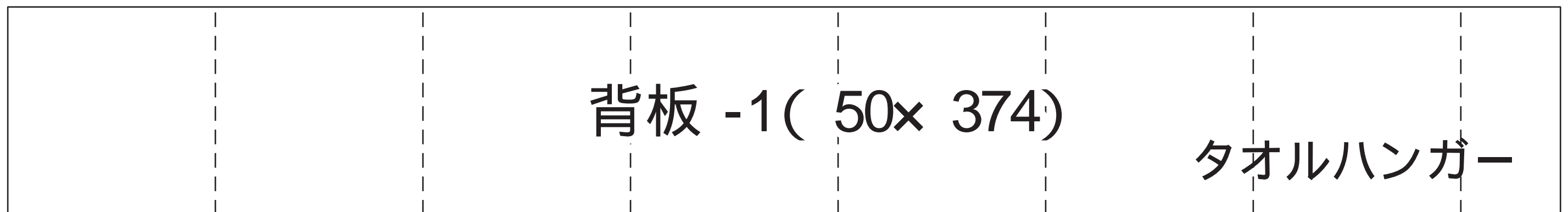

タオルハンガー型紙

掛け板、棚板 -2 仕切り板

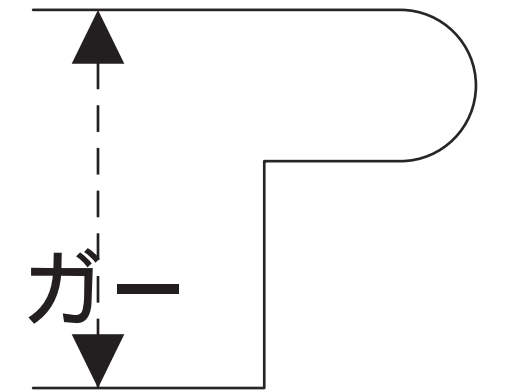
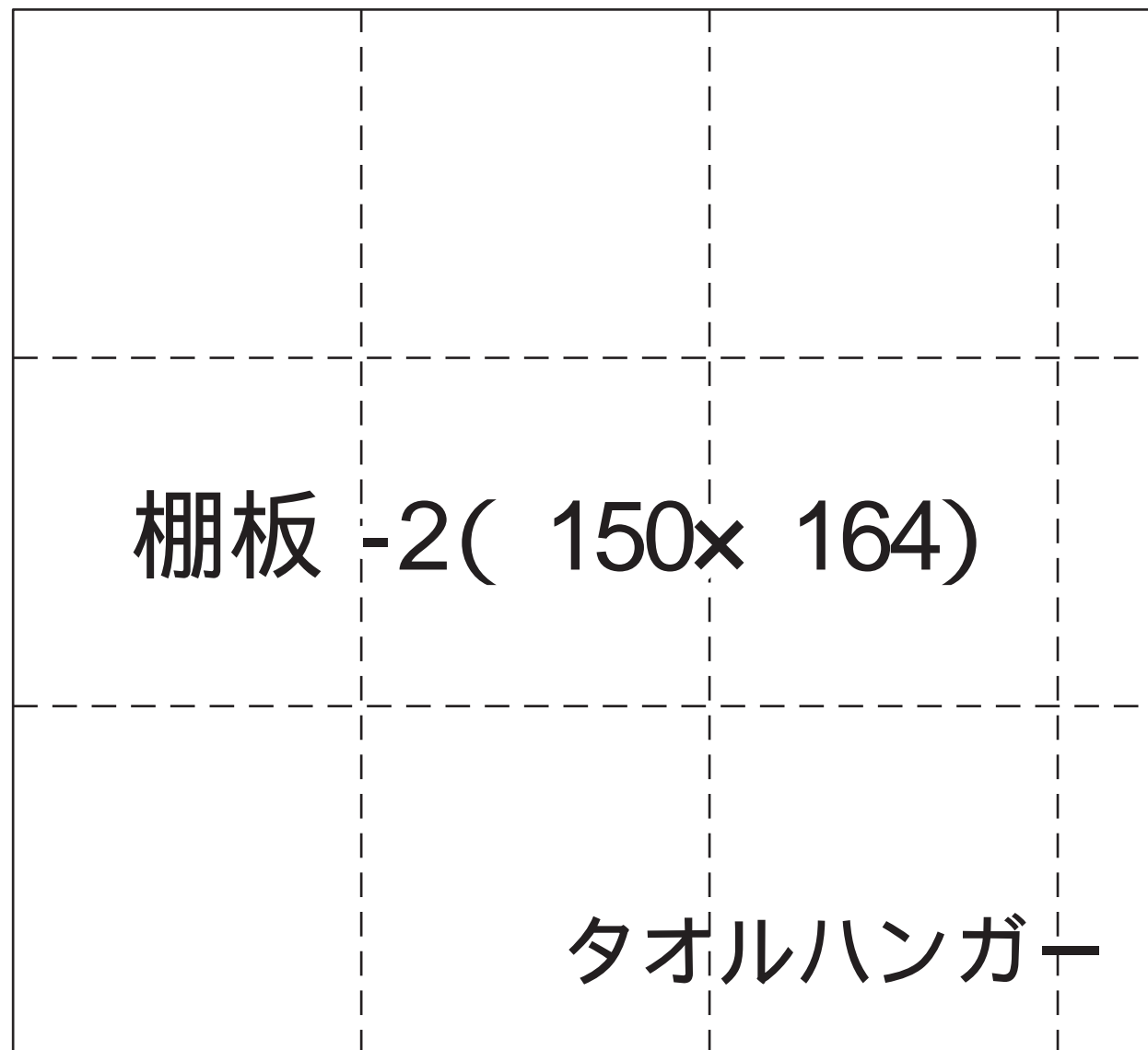
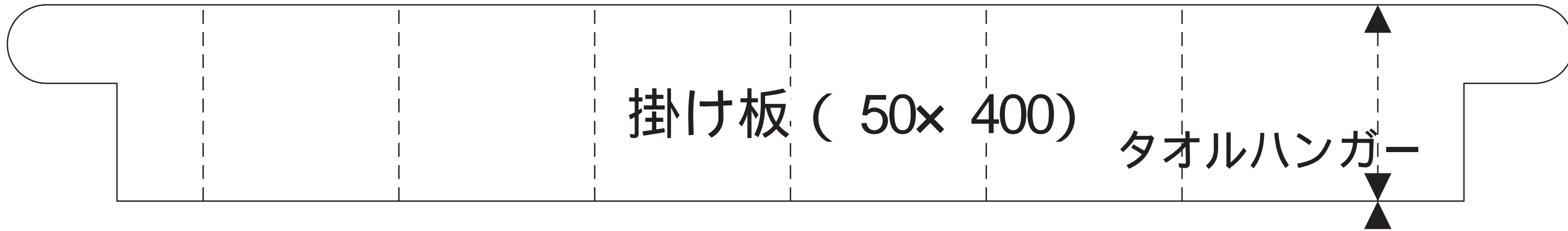





調味料スタンド型紙

背板 -2 底板 / 棚板、背板 -1

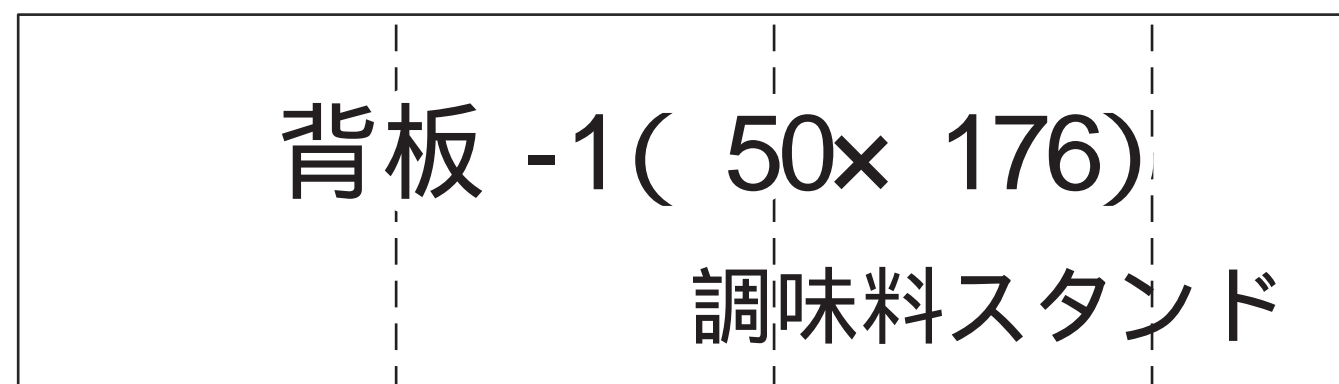
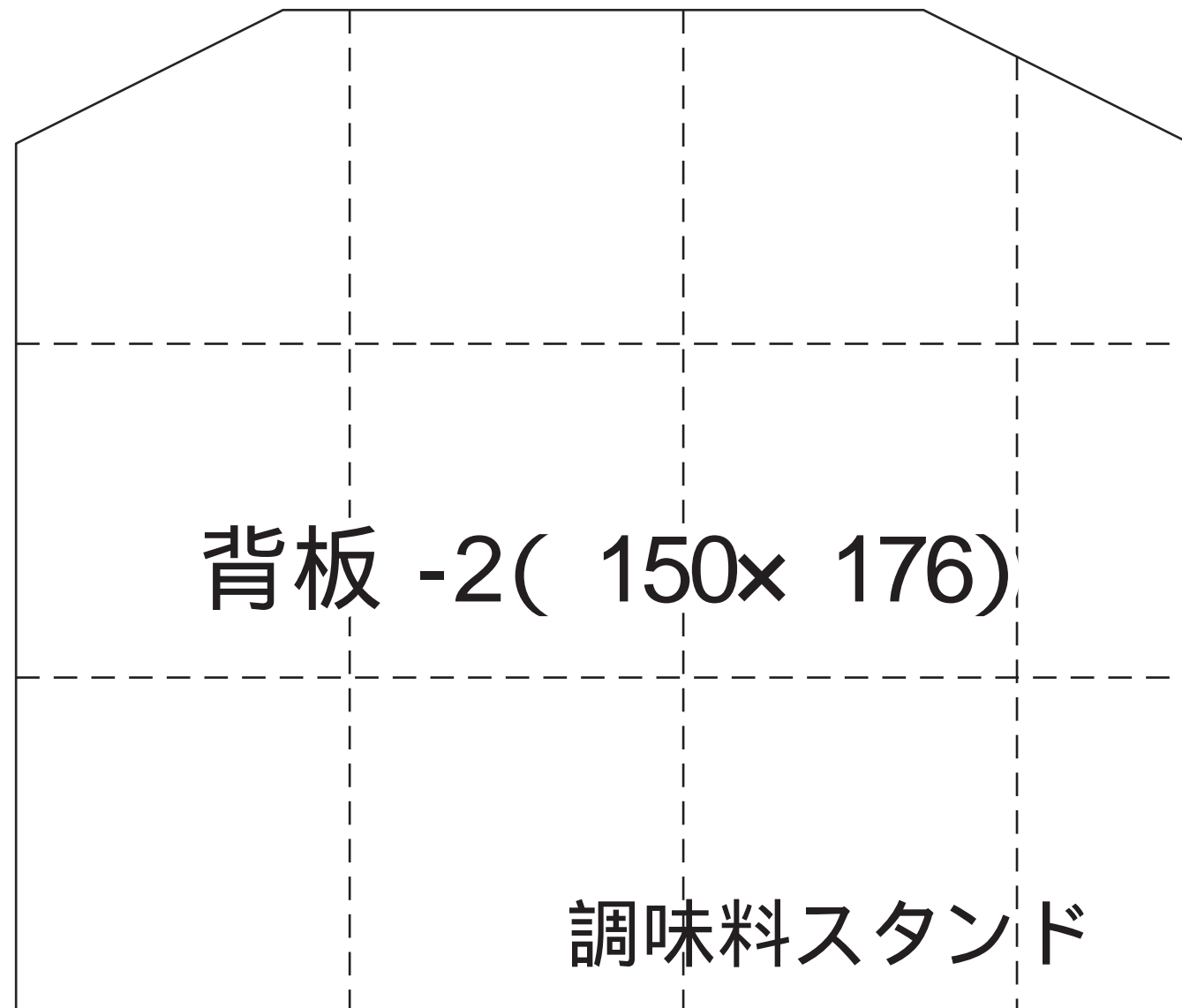



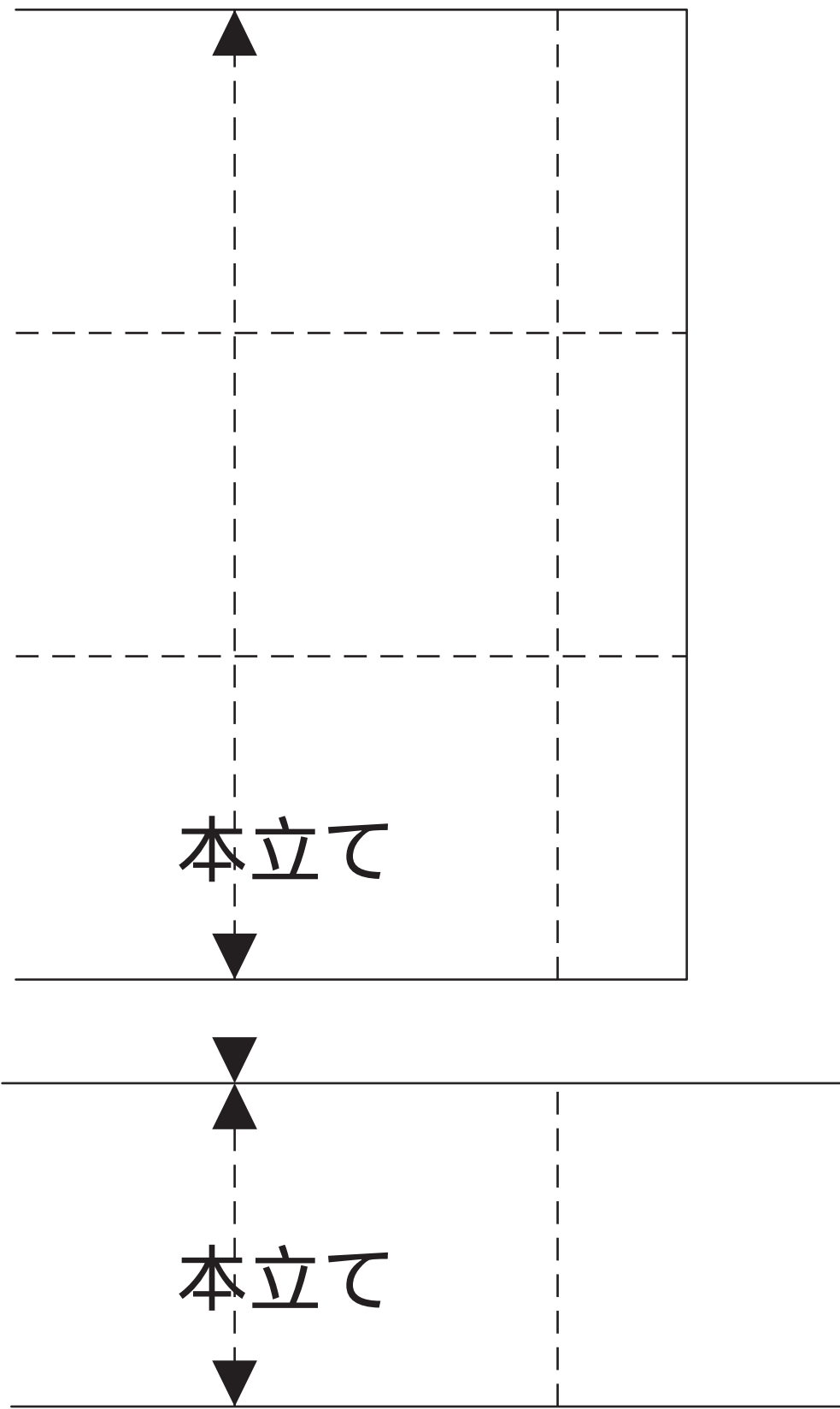

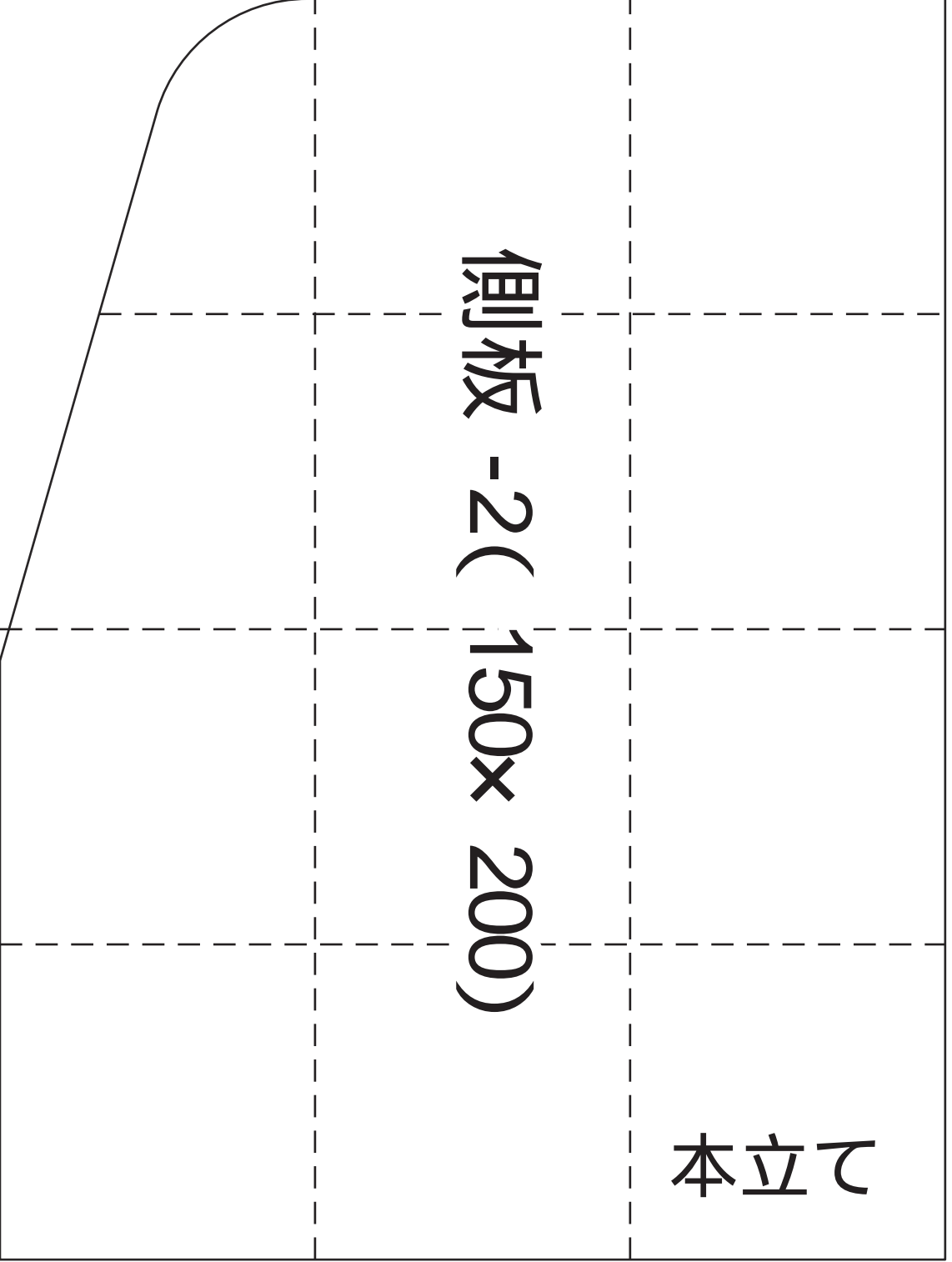
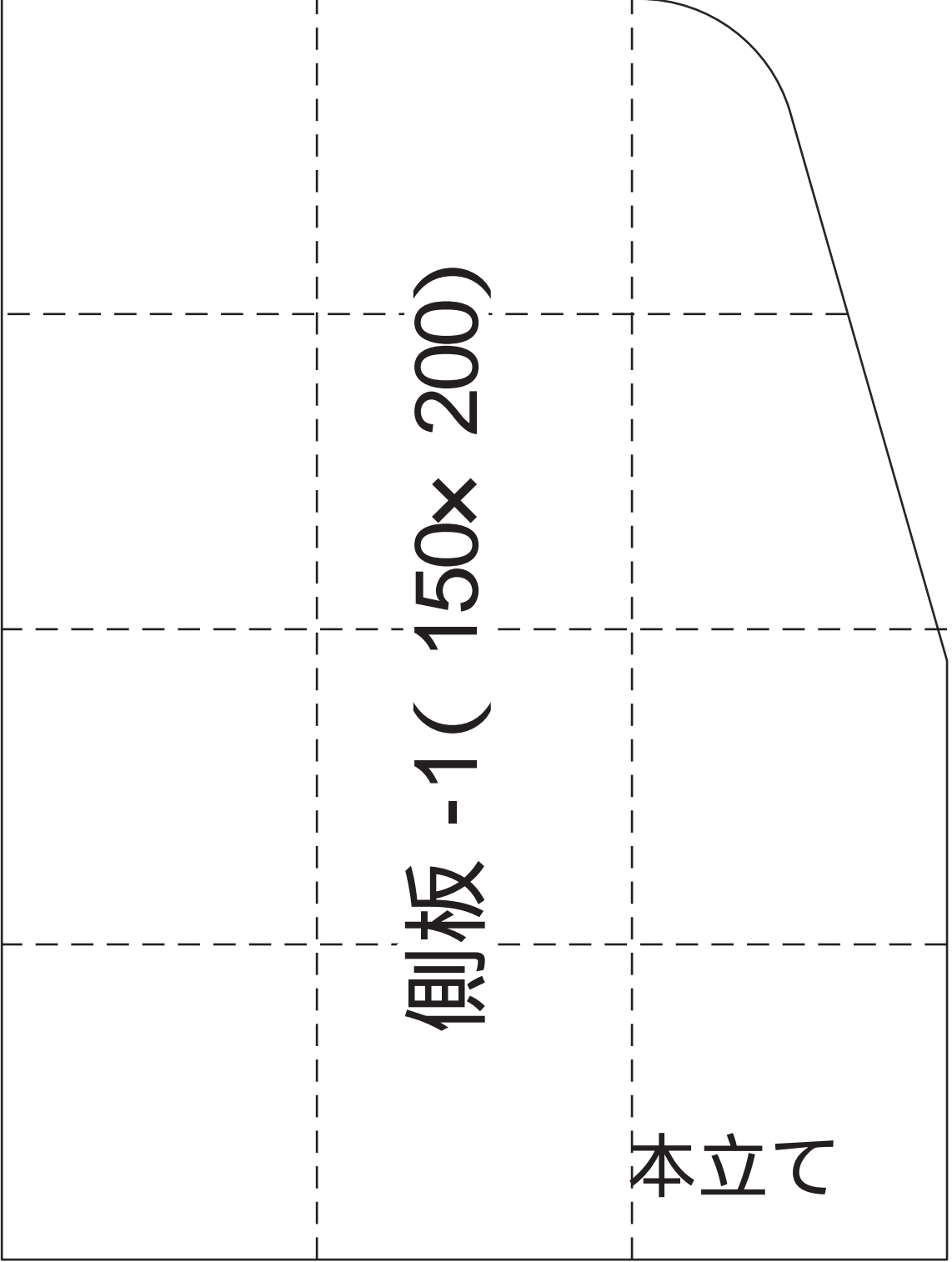

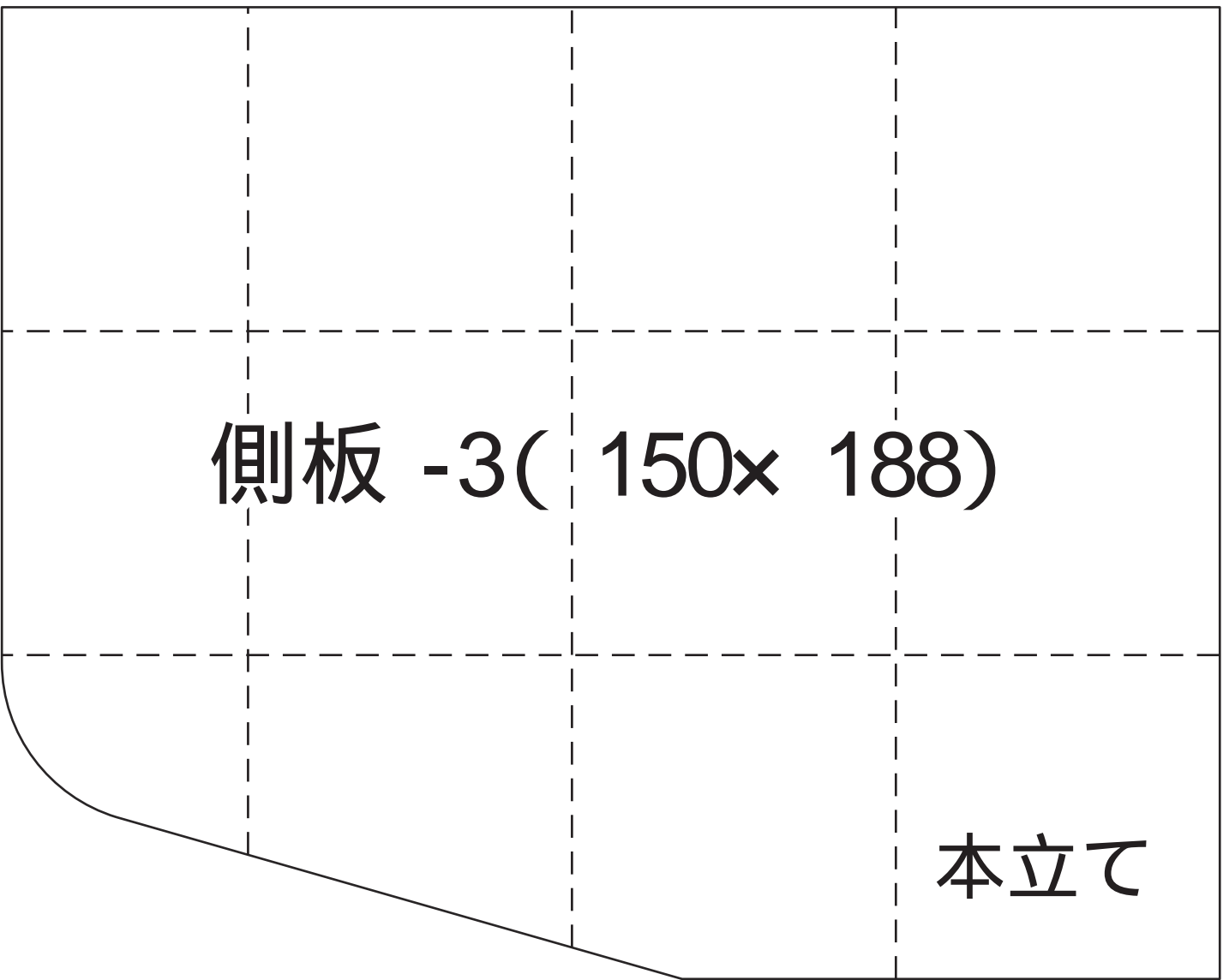



側板 -1 (150× 440)

二段ODラック

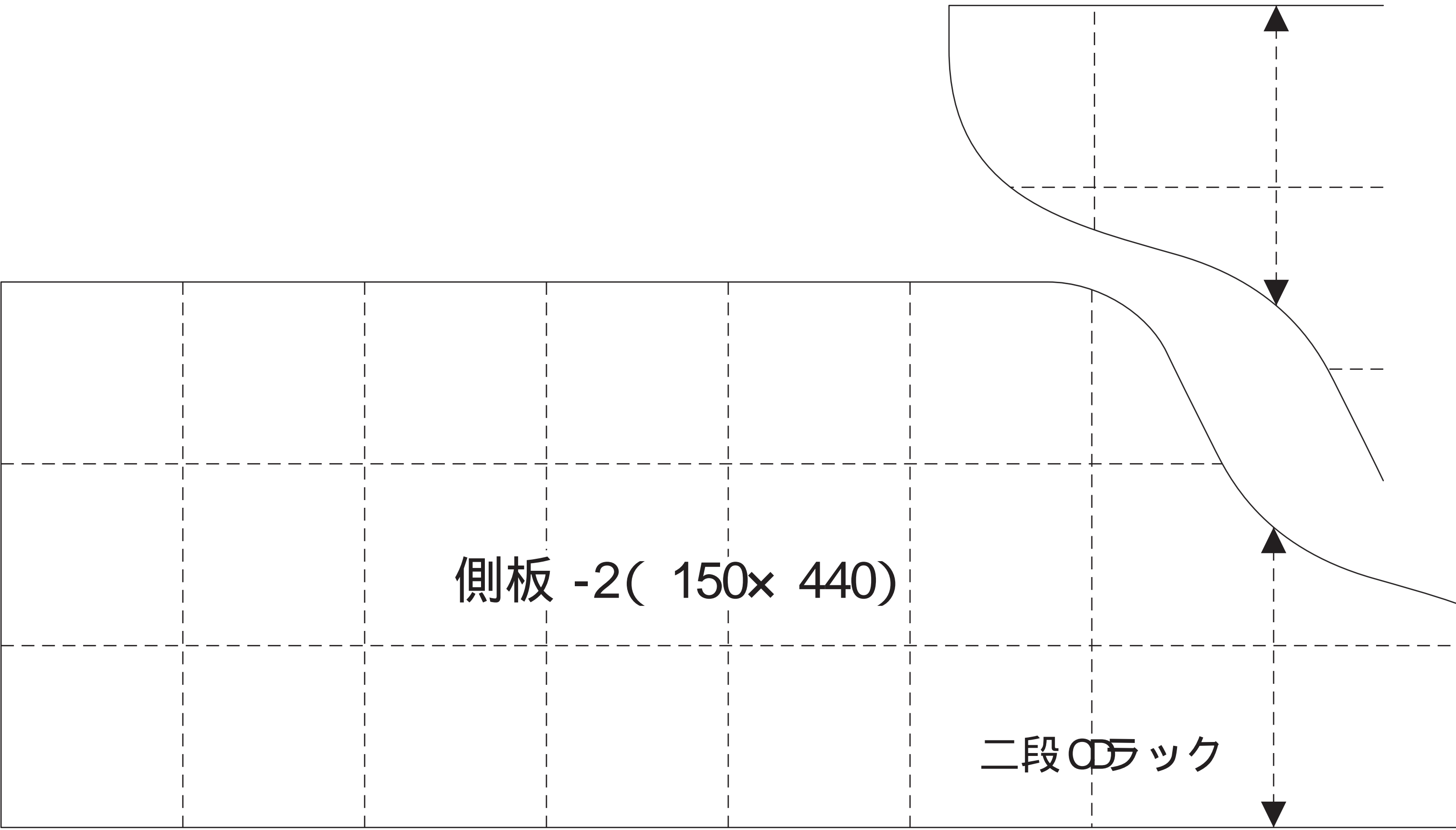

二段ODラック型紙

背板 -1 背板 -2 底板 / 棚板 -2 棚板 -1

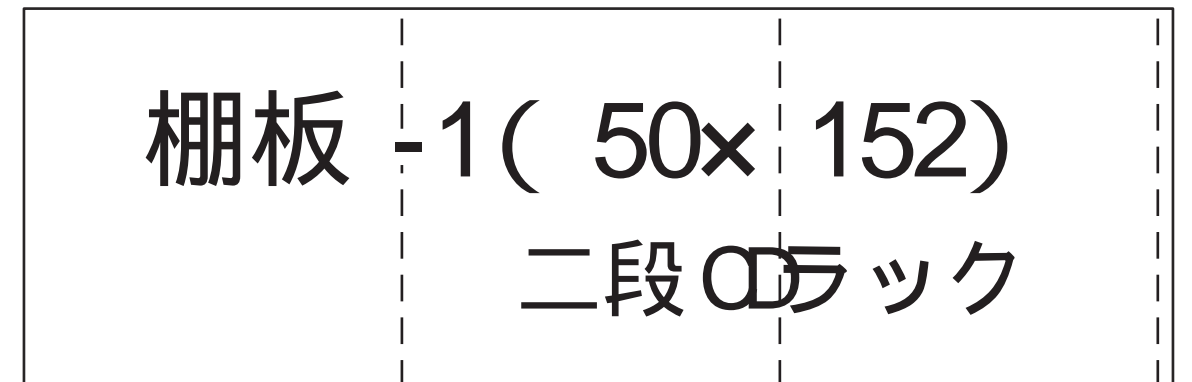
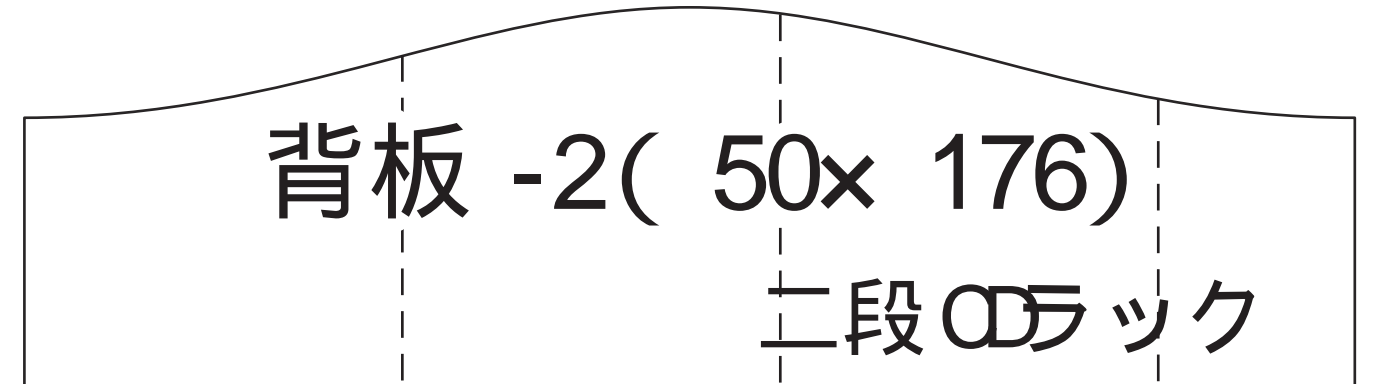
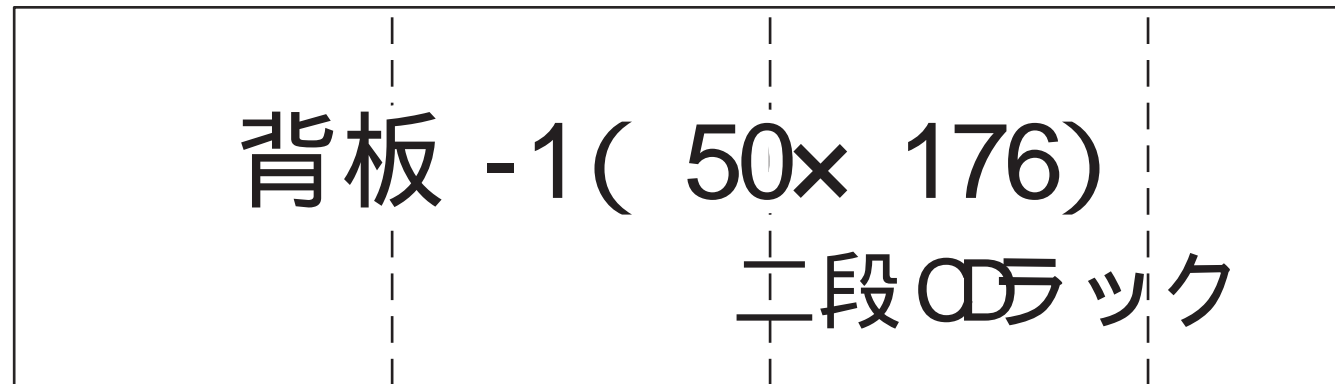

引き出し部 / 練習材

側板 A、側板 B/ 側板 C 練習材 A 練習材 B

